







## Slagleklipper med fast tårn

Model					Trepunktsfæste		Højde til liftarm	Min. afstand liftarme		
	Bredde cm	Antal slagler	Antal remme	AxBxC cm		Sideforskudt cm	cm	cm	hk	kg
HNEFN95	95	15	3	70x104x75		45/50	23	50	14-25	125
HNEFN115	115	21	3	70x124x75		47/68	23	50	14-25	155
HNEFN135	135	24	3	70x144x75		57/78	23	50	14-25	185
HNEFGC105	102	16	3	79x120x90	Center placeret	52/53	28	67	18-25	250
HNEFG125	122	20	3	79x140x90	Sideforskudt	60/65	28	67	18-25	277
HNEFGC150ZM	152	24	3	79x170x90	Sideforskudt	60/90	28	67	30-50	342
HNEFGC175ZM	172	28	3	79x190x90	Sideforskudt	60/115	28	67	40-50	392
HNEFGC200	200	32	4	79x218x90	Sideforskudt	80/120	28	77	55-70	430
HNEFGC220	220	36	4	79x238x90	Sideforskudt	80/140	28	77	75-90	470

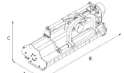
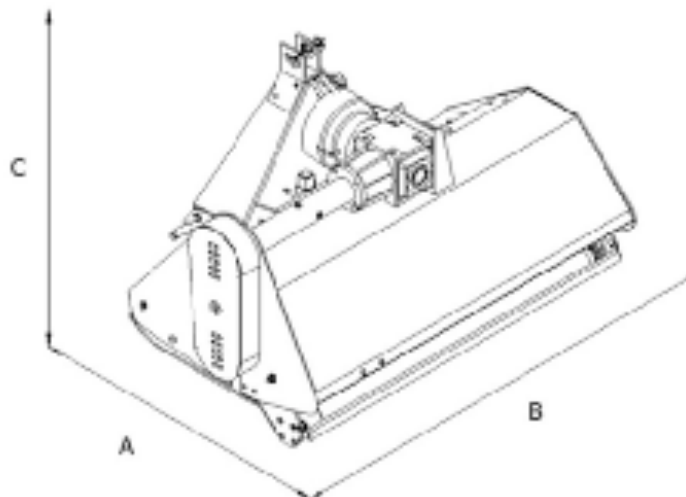

**DK·TEC**