







Fræsere

Model					Trepunktsfæste		Højde til liftarm	Min. afstand liftarme	 HP	 kg
	Bredde cm	Antal knive	Arbejds- dybde cm	AxBxC cm		Sideforskudt cm	cm	cm	hk	kg
HNFTL95	95	8+8	9	73x97x92		45/50	30	30	12-20	146
HNFTL115	115	12+12	9	73x117x92		53/62	30	30	15-22	160
HNFTL135	135	14+14	9	73x137x92		65/70	30	30	18-30	180
HNIGN105	105	15+15	15	95x123x100	Sideforskudt	52/53	43	67	20-30	265
HNIGN120	125	18+18	15	95x143x100	Sideforskudt	58/71	43	67	25-30	285
HNIGN150	150	21+21	15	95x173x100	Sideforskudt	67/88	43	67	30-40	320
HNIGN180	180	24+24	15	95x203x100	Sideforskudt	77/107	43	80	40-50	350
HNIGNA200	200	27+27	16	103x217x114	Center placeret	100/100	48	80	50-60	478
HNIGNA230	230	30+30	16	103x247x114	Center placeret	115/115	48	80	70-80	512

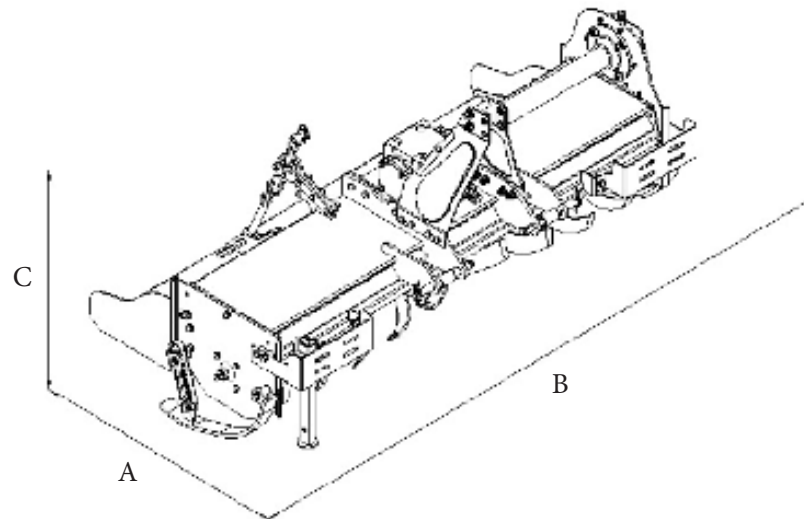

DK·TEC